

V-Flex 13.7W/m type

(Pre-wired Multi-Module / In Single Housing Type)

V-Flex is a brand of product series that is designed and developed by Brownie Ecotronics, mainly targeted for cove lighting application.

The perfect solution for general cove lighting. Available in CCT 2200K, 2500K, 2700K, 3000K, 3500K, 4000K and 6500K. All luminaires of these series are designed horizontally-bendable with dark spot-less in between fittings. The fixture length of this series is also customizable, perfect for vanity mirror and other indirect lighting.

DC24V

13.7W/m / 9W/m
3.0W/m

IP65

Semi-Outdoor

Ra85 typ.
(applicable for
CCT 2700K
above)

Dimmable
(Dali, DMX,
0-10V)

Custom
Length
(Build-to-order
basis)

1 meter
Single Housing Type

Pre-wired
Multi-Module Type

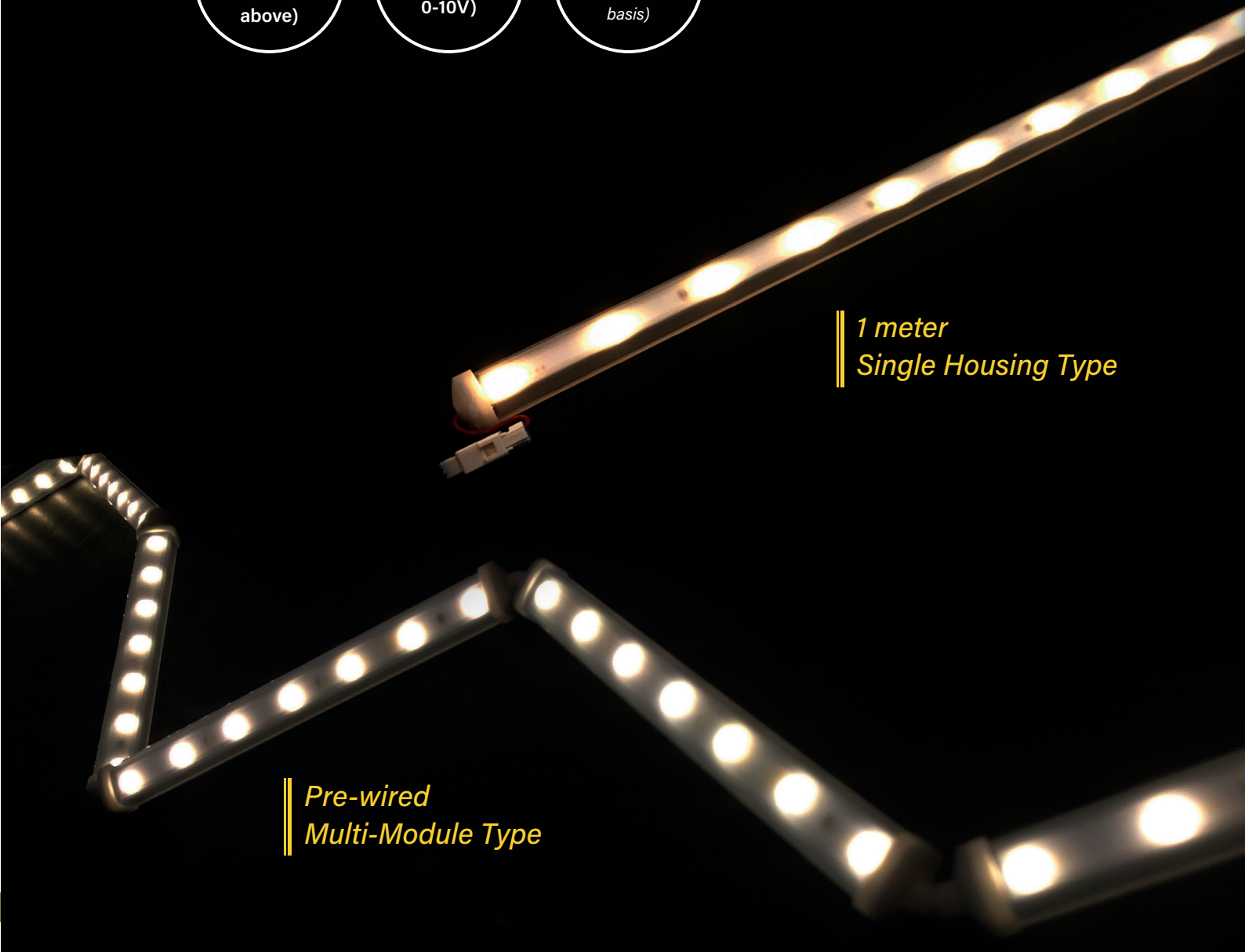

COMPETITIVE ADVANTAGE

1. Rigid Yet Flexible:

Electrical connection error or solder crack are very common problems found in conventional LED strips that uses flexible PCB. In order to eliminate these problems, V-Flex incorporates overmoulded polymer between pre-wired fixtures, thus greatly enhances product reliability and at the same time achieving uniform lighting effect that are free of dark spots in the typical cove application. The overmoulded polymer can be twisted and bent up to 180° at all X.Y.Z (omnidirectional) directions, further enhance the flexibility of application.

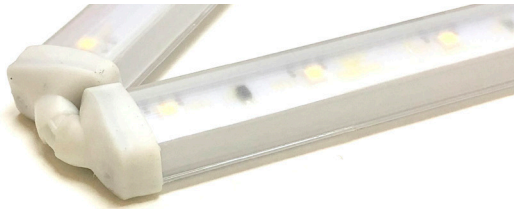

Overmoulded polymer at every end-cap

2. Minimized Risk of Dark-Spot at Fixture-to-Fixture Joint Area:

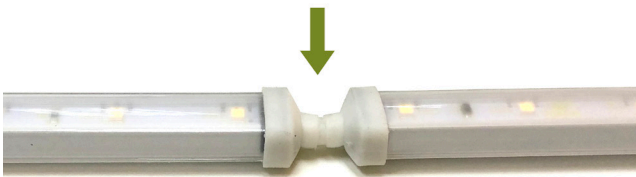

Cutable on Site (at every L190mm)

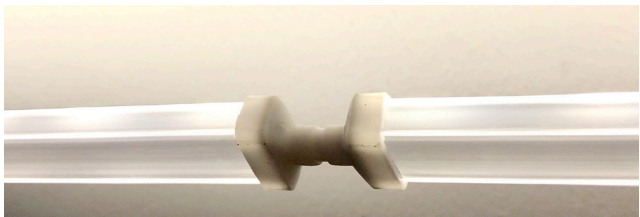

50mm away from the wall surface
→ Perfect uniformity / No dark spot

3. Reliable NICHIA, Single & Center Colour Binning:

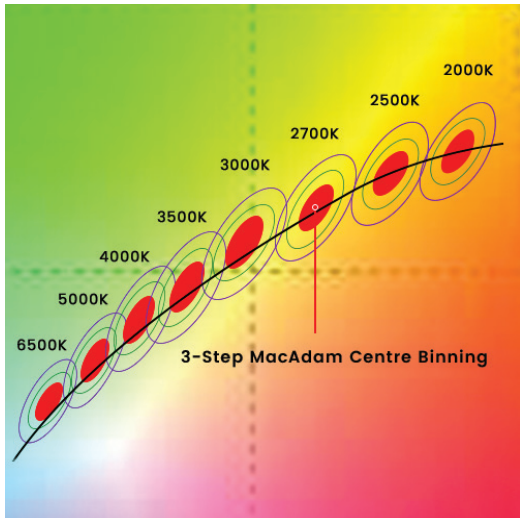

Nichia Chromaticity Diagram: Brownie Ecotronic is using the 3-Step MacAdam Centre Binning to ensure the excellent color consistency of our LED.

4. Cutable at Every L190mm Module Unit

5. Reverse Polarity Protection Circuit Built-in

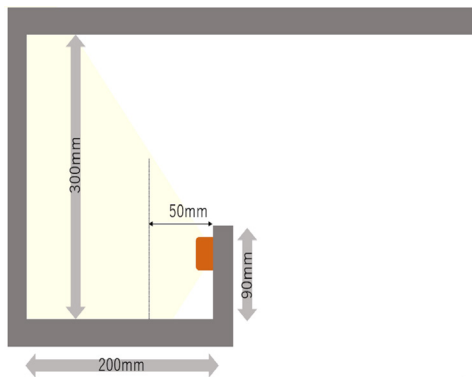

Conventional Mounting Method for Curved Ceiling Cove



Brightness enhanced by approx. 40% (=Minimized Energy)

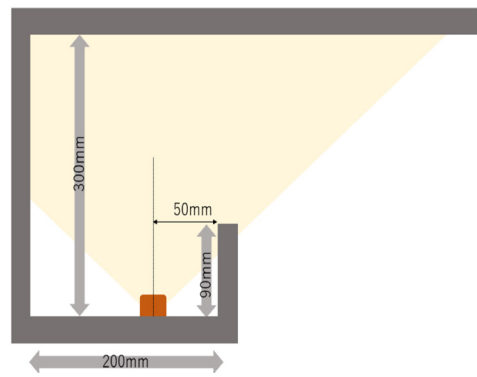

13.7W/METER TYPE

FEATURES

- Perfect solution for general cove lighting.
- Rigid fixture, yet horizontally-bendable.
- Available in CCT 2200K, 2500k, 2700K, 3000K, 3500K, 4000K and 6500K.
- Excellent efficiency using NICHIA Japan LED with optimized circuit design and tight-controlled chip's Vf properties.
- Dark spot-less in between fittings minimized voltage drop due to unique design of power compensation wire.
- Excellent colour consistency MacAdam 3 Step Centre Binning (right on top of black locus body line).
- Three (3) types of wattage and brightness; 13.7W/n 9.0W/m and 3.0W/m.
- Protection circuits equipped against reverse polarity.

BASIC SPECIFICATION

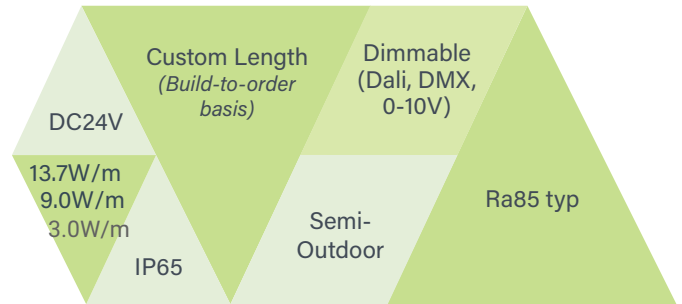

5-in-1 Pre-wired VF1000-353A-W (L1000mm)

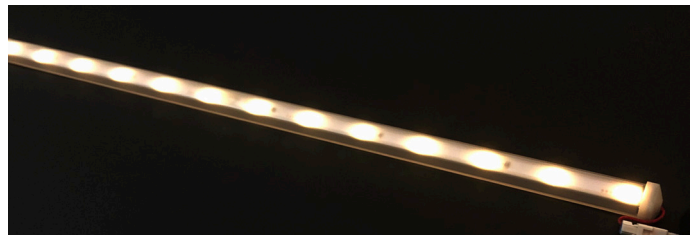

Single Housing Type VF10SH-273A-W (L1000mm)

PRODUCT SPECIFICATIONS

Product Name	V-Flex 13.7W/meter Type				
Model No.	VL3000-XXXA-W (L3000mm), 15-in-1 Pre-wired	VL1000-XXXA-W (L1000mm), 5-in-1 Pre-wired	VL10SH-XXXA-W (L1000mm), In Single Housing	VL0600-XXXA-W (L600mm), 3-in-1 Pre-wired	VL0200-XXXA-W (L200mm), In Single Housing
Input Voltage	24Vdc	24Vdc	24Vdc	24Vdc	24Vdc
Power Consumption	41.1 W	13.7 W	13.7 W	8.2 W	2.7 W
Dimension (mm)	3000*19*12(H)	1000*19*12(H)	1000*19*12(H)	600*19*12(H)	200*19*12(H)
Weight	570 grams	190 grams	190 grams	112 grams	38 grams
Casing Body	Aluminium Heatsink with UV-resistant Polycarbonate Semi-Frosted Diffuser				
LED Beam Angle	110°	110°	110°	110°	110°
Operating Temperature	-10°C~50°C	-10°C~50°C	-10°C~50°C	-10°C~50°C	-10°C~50°C
Max. Length of Series Connection	5 meter	5 meter	5 meter	5 meter	5 meter
Option Parts	Mounting clip bracket 0° (flat) type / 45° fixed angle type				
No of LEDs	105	35	28	21	7
Power Supply Unit (Gear-Driver)	24Vdc Contant-Voltage Switching Power Supply (TDK Lamba, Sold Separately)				
Dimmable Control	Dimmable	Dimmable	Dimmable	Dimmable	Dimmable
Lumens (typical @ 3000K)	4690	1590	1590	954	318

Available LED Colour: 6500K, 4000K, 3500K, 3000K, 2700K, 2500K, 2200K (* 6500K and 2200K are build-to-order)

MODEL NO

Model No **XX** **XXXX** **—** **XXXA** **—** **W**

Fixture Type
Fixture Length
Color Temperature & Color Rendering Index
Connector

Fixture Type

- VF → V-Flex Standard (9.0W/m)
- VL → V-flex Hight Wattage type (13.7W/m)

Fixture Length

- 1000 → 1m L1000mm, 5-in-1 Pre-wired Module
- 10SH → 1m L1000mm, **Standard**, In Single Housing
- 0600 → L600mm, **Standard**, 3-in-1 Pre-wired Module
- 0200 → L200mm, **Standard**, In Single Housing
- 12SH → L1200mm, Build-to-order, In Single Housing
- 3000 → L3000mm, Build-to-order, 15-in-1 Pre-wired Module

Color Temperature & Color Rendering Index

- 653A → Daylight 6500K, CRI Ra85 typical, Build-to-order
- 403A → Cool White 4000K, CRI Ra85 typical
- 353A → 3500K, CRI Ra85 typical
- 303A → Light Warm White 3000K, CRI Ra85 typical
- 273A → Standard Warm White 2700K, CRI Ra85 typical
- 253A → Dark Warm White 2500K, CRI Ra85 typical
- 223A → Amber-Like Warm White 2200K, CRI Ra85 typical, Build-to-order

Connector

- W → with IP65 male-female connector, **Standard**
- N → with non-IP male-female connector, custom spec (Build-to-order)



for waterproof connector



for non-waterproof connector

Example **VL** **1000** **—** **303A** **—** **W**

Fixture Type

V-Flex 13.7W/m

Fixture Length

1 meter L1000mm, Standard, Pre-wired 5-in-1 Type

Color Temperature & Color Rendering Index

Light Warm White 3000K, CRI Ra85 typical manufactured by NICHIA Japan

Connector

with waterproof IP65 male-female connector

MECHANICAL DRAWING

1

190mm = 1-in-1

VF0200-XXXX-W /
VL0200-XXXX-W

L200mm in Single
Housing

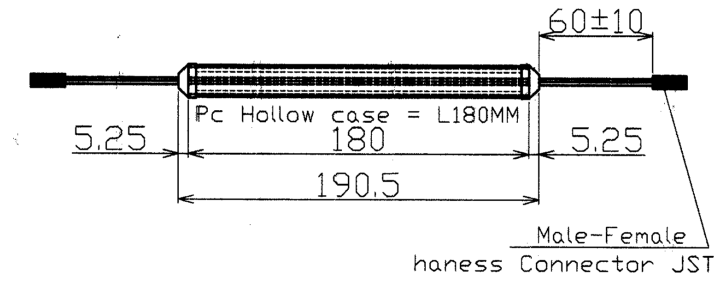

191mm

2

Approx.
0.6m = 3-in-1

VF0600-XXXX-W /
VL0600-XXXX-W

L600mm
3 Modules Pre-wired

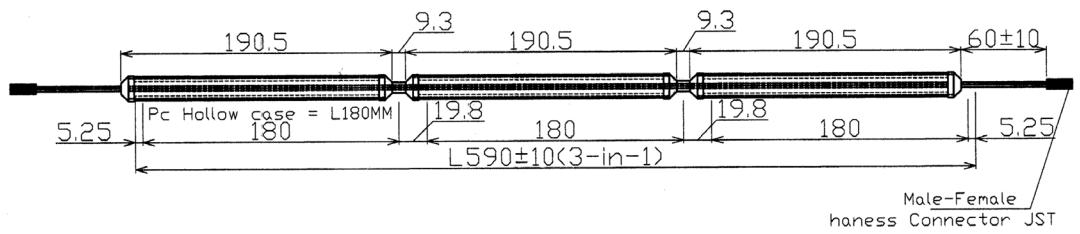

599mm

3

1m in Single
Housing

VF10SH-XXXX-W /
VL10SH-XXXX-W
L1000mm in Single
Housing

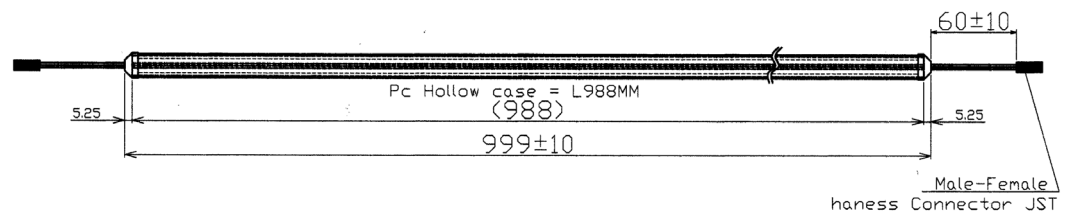

999mm

4

Approx.
1m = 5-in-1

VF1000-XXXX-W /
VL1000-XXXX-W

L1000mm
5 Modules Pre-wired

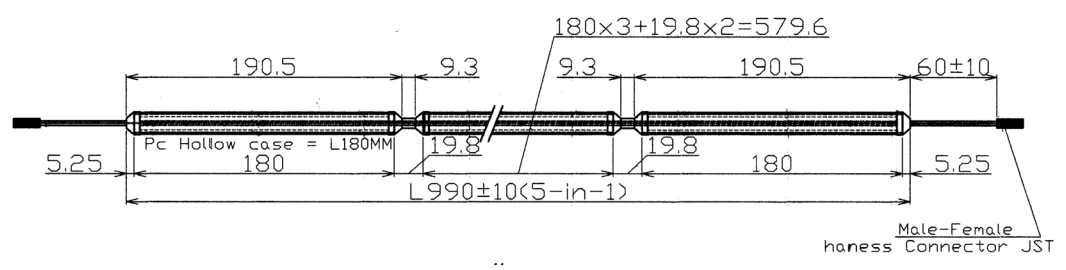

5

Approx.
3m = 15-in-1

VF3000-XXXX-W /
VL3000-XXXX-W

L3000mm
15 Modules Pre-wired

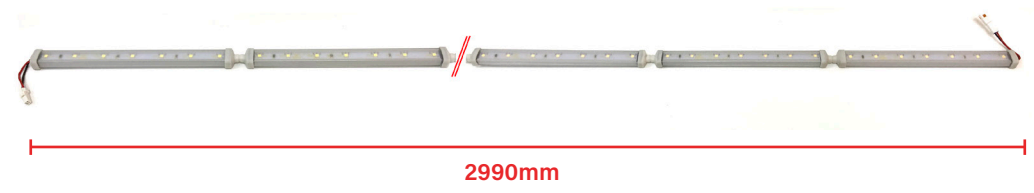
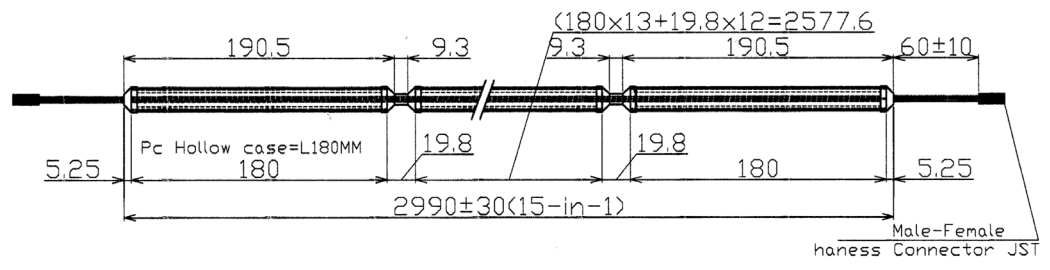

For Waterproof Connector:
Male-Female Connector
(Standard spec comes with this connector)

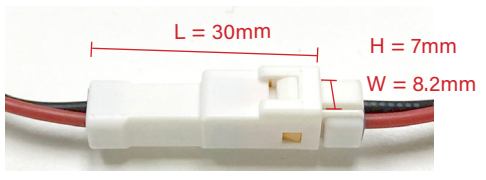

Red Cable = Positive (+)
Black Cable = Negative (-)

For Waterproof Connector:
Male-Female Connector
(Custom-made non-waterproof type, build-to-order)

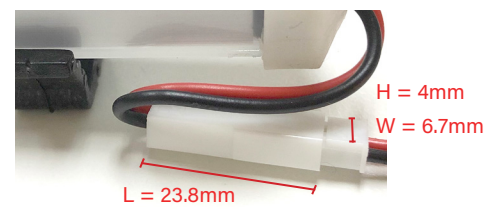

White /or Red Cable = Positive (+)
Black Cable = Negative (-)

OPTIONAL ACCESSORIES

1 Mounting Clip Bracket 0° Flat Type

Model: MC-0DEG

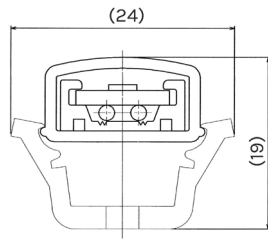
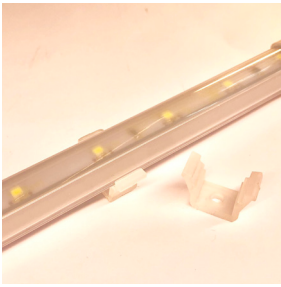

2 Mounting Clip Bracket 45° Type

Model: MC-45DEG

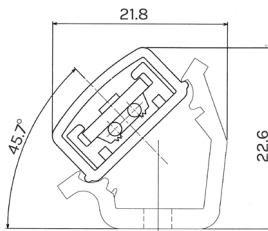

3 Metal Mounting Clip 30° Type

Model: MMC-30DEG

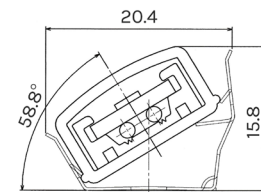

4 Aluminum Guide Rail

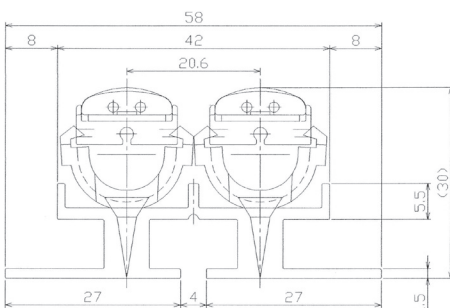
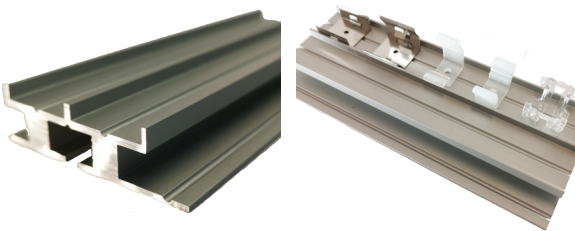

PHOTOMETRICS

BROWNIE Lab 190214
VL1000-303A-W

Article No.: VL1000-303A-W
Luminous flux (Luminaire): 1590 lm
Luminous flux (Lamps): 1590 lm

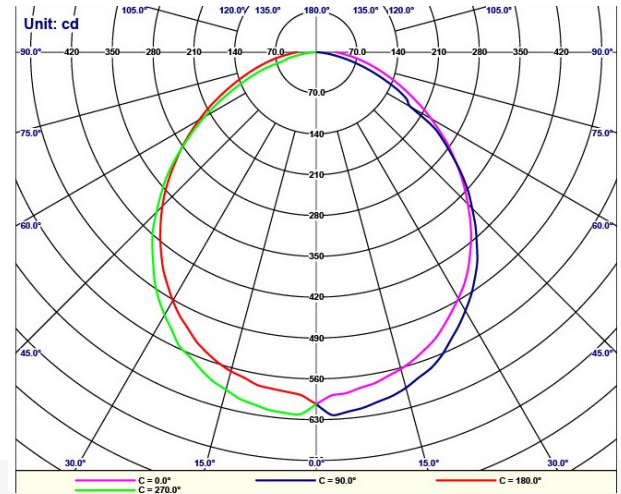

VL0600-303A-W

Article No.: VL0600-303A-W
Luminous flux (Luminaire): 954 lm
Luminous flux (Lamps): 954 lm

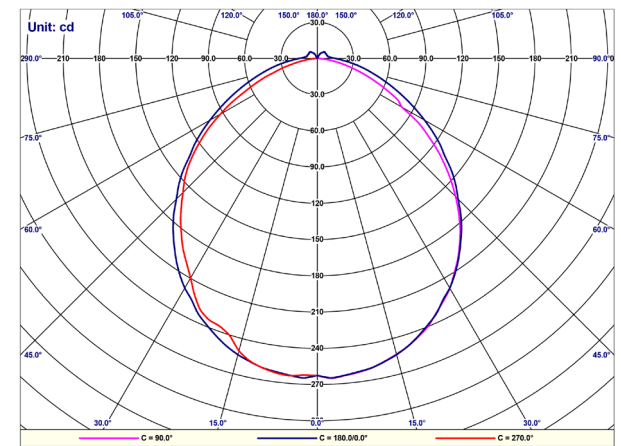

BROWNIE Lab 190223
VL0200-303A-W

Article No.: VL0200-303A-W
Luminous flux (Luminaire): 318 lm
Luminous flux (Lamps): 318 lm

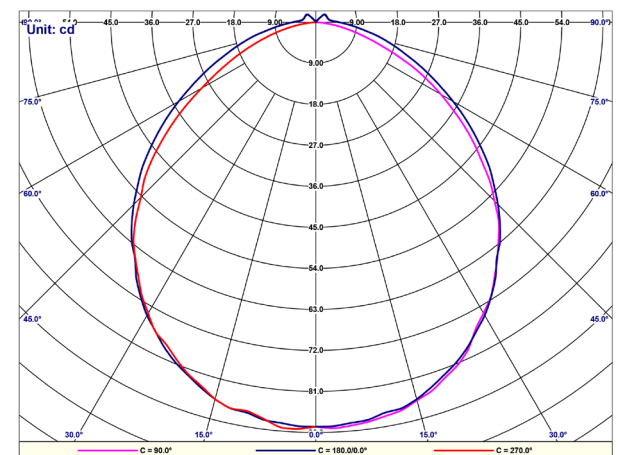

:: For IES data, please contact our sales staff or distributor

PROJECT REFERENCE



NUS HALL - Using V-Cove 3000K with DMX dimming driver - V-Dimmer-3

Photo by: Lighting Planners Associates



Kinokuniya Book Shop at Takashimaya using V-Cove (ver 1) 3000K